

MASTERSEAL 6

▪ VERSIONS	2
▪ TECHNICAL DATASHEET	3
▪ APPLICATIONS	4
▪ MAINTENANCE	5
▪ CONFIGURATION	6



PREMIUM WATERPROOF ZIPPERS MADE IN GERMANY



waterproof



airtight



pressure tested

MASTERSEAL 6

VERSIONS

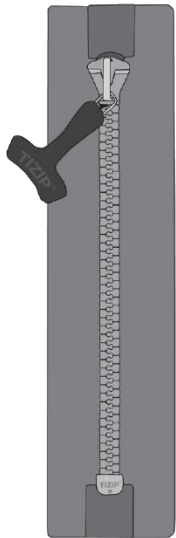

1 slider



both sides closed

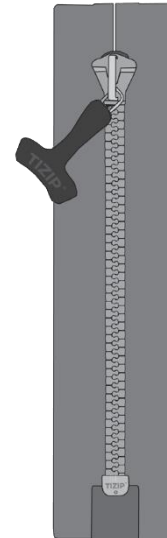

1 slider



one side open

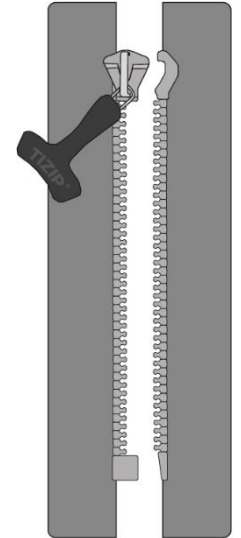

1 slider



separable

MASTERSEAL 6

TECHNICAL DATASHEET

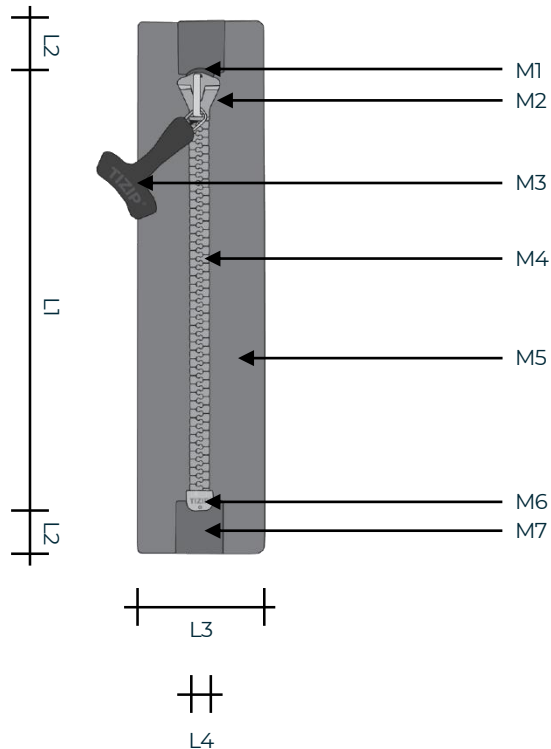

Geometry*

- L1 Order length: 130 - 7.000 mm
- L2 Overhang length: 16 mm / 25 mm
- L3 Tape width: 40 mm / 50 mm
- L4 Chain width: 6 mm

Material*

- M1 Docking End: Thermoplastic Polyurethane
- M2 Slider: Polymer
- M3 Puller: Thermoplastic Polyurethane
- M4 Chain: Polyester
- M5 Tape: Polyurethan coated Polyester
- M6 End Stop: Thermoplastic Polyurethan
- M7 Pattern: Polyurethan coated Polyester

Parameter*

- ☔ Sealing strength: 200 mbar
- ↔ Cross tension: 160 N/cm
- 🌡️ Temperatur: -30° to +70° C

Installation*

HF welding, sewing/taping, gluing

*configuration-dependent target values

MASTERSEAL 6



APPLICATIONS / DURABILITY / INSTALLATION

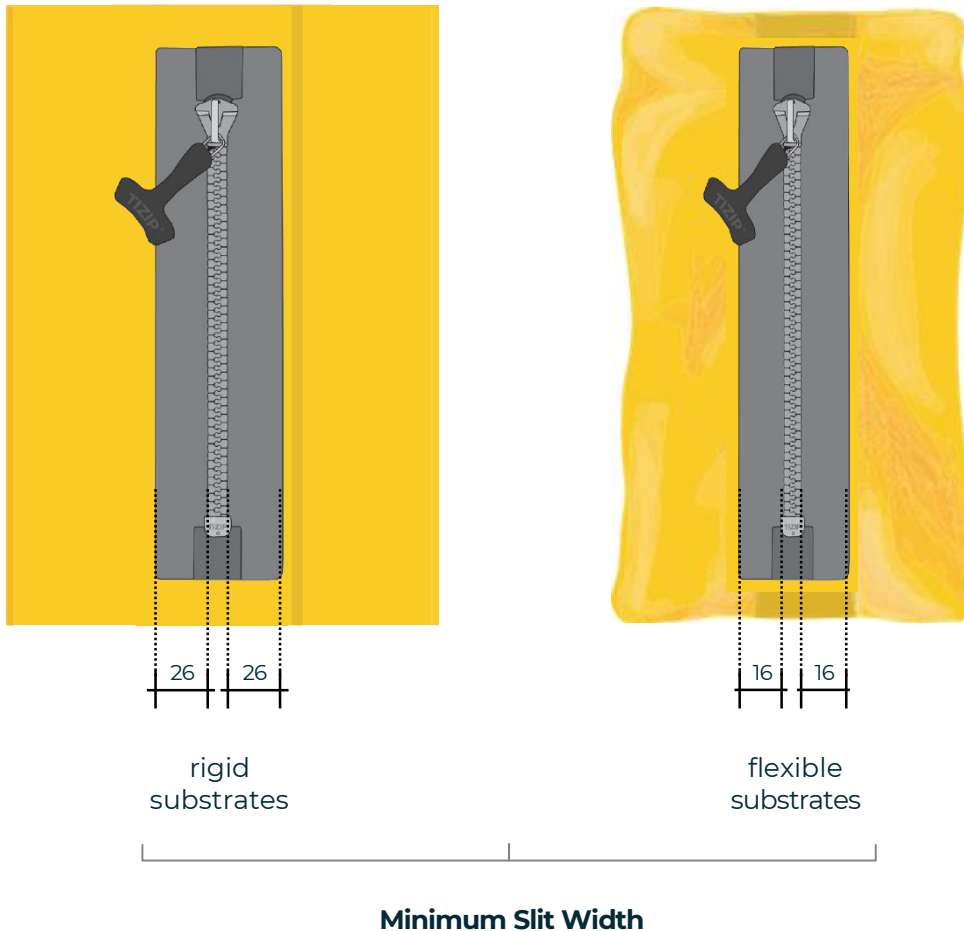

Applications

- Swimming shorts
 - Waders
- Water Sports
- Motorcycle jackets & pants
 - Hiking- / skiing jackets & pants
 - Protective & survival
 - Shoes
- Clothing
- Tents, covers
 - Backpacks, duffel bags, cooler bags
 - Other
- Outdoor

Durability

- Weather-resistant
- Suitable for both freshwater and saltwater applications
- Oil and gasoline-resistant

Installation

- A minimum slit width of 16 mm is recommended for all types of substrates.
- With rigid substrates (fabric, foils, neoprene, etc.) the slit width should be increased to at least 26 mm.
- The zip must not be roughened for installation.
- The welding temperature, welding time, welding electrode and contact pressure must be optimally adjusted to the zipper (material, geometry, etc.). Tests are recommended before installation.

MASTERSEAL 6

BEST PRACTICE / CLEANING / STORAGE

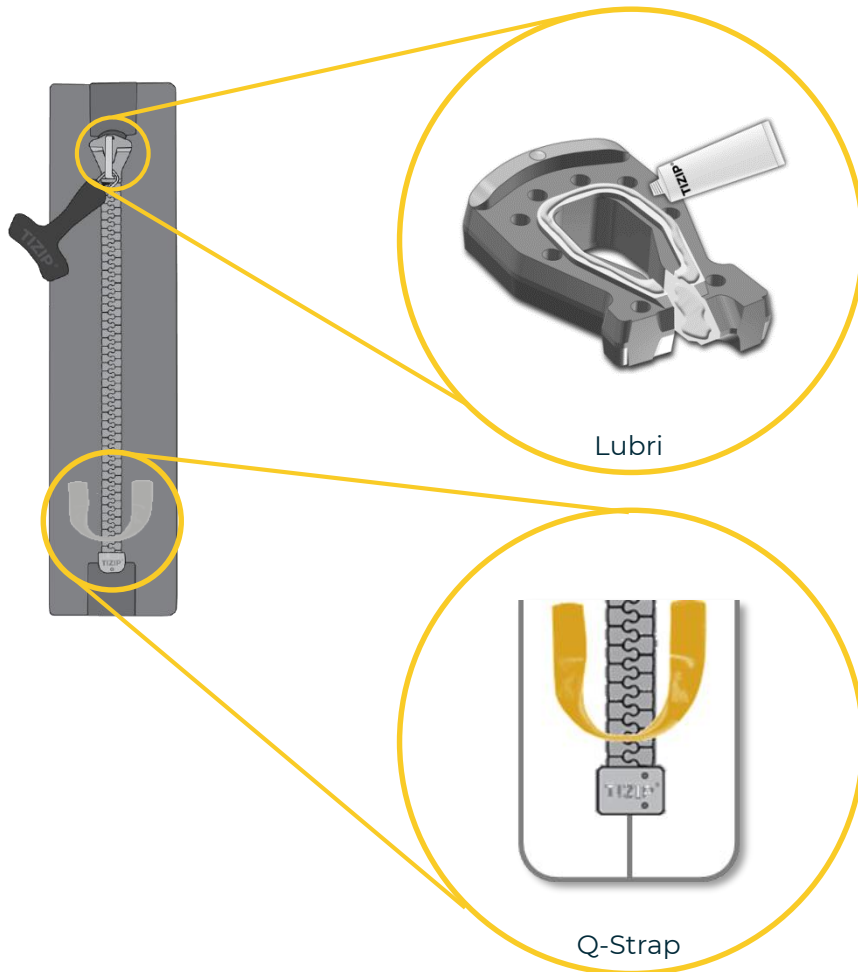

Best Practice

- Operate the slide gently. Pulling at an angle can negatively affect the zippers, e.g. their tightness.
- Avoid overstretching the docking end and end pieces if necessary by using the optional Q-Strap. Do not pull the two sides of the zipper apart forcefully.
- Be careful not to fold or squeeze the zippers.
- Close each zipper carefully so that the slider lies correctly in the docking end to guarantee tightness.

Cleaning

- Dirt particles, especially between the teeth, can affect the sealing lip and thus negatively affect the tightness and durability.
- We recommend a light soapy water and a fine brush.
- Do not use solvents or aggressive cleaning agents as these negatively affect the function of the zipper.

Lubrification

- MasterSeal zippers need to be lubricated from time to time.
- Apply gently the lubricating grease in the area of the docking end on the front and back, as well as on the inside at the transition to the zip chain.
- Do not use grease along the zipper chain.
- Remove remaining lubricating grease to avoid stains.
- Use the original TIZIP® lubricating grease.

Storage

- TIZIP® zippers should be stored completely closed, dry, clean and without bending.

MASTERSEAL 6

CONFIGURATION



1.0 Tape

1.1	Overhang	25 mm
1.2	Overhang	16 mm
1.3	Width	40 mm
1.4	Width	50 mm
1.5	Optic	plain
1.6	Optic	structured
1.7	Optic	custom

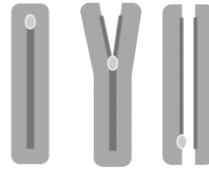

<input checked="" type="checkbox"/>	<input checked="" type="checkbox"/>	<input type="checkbox"/>
<input type="checkbox"/>	<input type="checkbox"/>	<input type="checkbox"/>
<input checked="" type="checkbox"/>	<input checked="" type="checkbox"/>	<input checked="" type="checkbox"/>
<input type="checkbox"/>	<input type="checkbox"/>	<input type="checkbox"/>
<input checked="" type="checkbox"/>	<input checked="" type="checkbox"/>	<input checked="" type="checkbox"/>
<input type="checkbox"/>	<input type="checkbox"/>	<input type="checkbox"/>
<input type="checkbox"/>	<input type="checkbox"/>	<input type="checkbox"/>

Black	RAL 7016	Pantone 000 C	Pantone 7501 C	Pantone 7497 C	Pantone 2426 C	Pantone 18-1555	Pantone 2174 C	Pantone 13-0752	Customized
<input checked="" type="checkbox"/>	<input type="checkbox"/>	<input type="checkbox"/>	<input type="checkbox"/>	<input type="checkbox"/>	<input type="checkbox"/>	<input type="checkbox"/>	<input type="checkbox"/>	<input type="checkbox"/>	<input type="checkbox"/>
<input checked="" type="checkbox"/>	<input type="checkbox"/>	<input type="checkbox"/>	<input type="checkbox"/>	<input type="checkbox"/>	<input type="checkbox"/>	<input type="checkbox"/>	<input type="checkbox"/>	<input type="checkbox"/>	<input type="checkbox"/>
<input checked="" type="checkbox"/>	<input type="checkbox"/>	<input type="checkbox"/>	<input type="checkbox"/>	<input type="checkbox"/>	<input type="checkbox"/>	<input type="checkbox"/>	<input type="checkbox"/>	<input type="checkbox"/>	<input type="checkbox"/>

Standard Option

MASTERSEAL 6

CONFIGURATION



2.0 Pattern

- 2.1 Position front side
- 2.2 Position back side

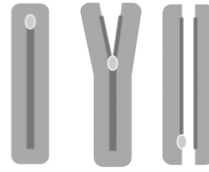

3.0 Teeth

- 3.1 Regular Quality 200 N/cm
- 3.2 Performance optimized (from 01.04.20) Easy operation & durability 160 N/cm

4.0 Slider

- 4.1 Standard Quality Polymer 0,2 bar
- 4.2 Brake System Polymer 0,0 bar



<input type="checkbox"/>	<input type="checkbox"/>	<input type="checkbox"/>	<input checked="" type="checkbox"/>	<input type="checkbox"/>	<input type="checkbox"/>	<input type="checkbox"/>	<input type="checkbox"/>	<input type="checkbox"/>	<input type="checkbox"/>	<input type="checkbox"/>	<input type="checkbox"/>
<input checked="" type="checkbox"/>	<input type="checkbox"/>	<input type="checkbox"/>	<input checked="" type="checkbox"/>	<input type="checkbox"/>	<input type="checkbox"/>	<input type="checkbox"/>	<input type="checkbox"/>	<input type="checkbox"/>	<input type="checkbox"/>	<input type="checkbox"/>	<input type="checkbox"/>

<input checked="" type="checkbox"/>	<input type="checkbox"/>	<input type="checkbox"/>	<input checked="" type="checkbox"/>	<input type="checkbox"/>	<input type="checkbox"/>	<input type="checkbox"/>	<input type="checkbox"/>	<input type="checkbox"/>	<input type="checkbox"/>	<input type="checkbox"/>	<input type="checkbox"/>
<input type="checkbox"/>	<input type="checkbox"/>	<input type="checkbox"/>	<input type="checkbox"/>	<input type="checkbox"/>	<input type="checkbox"/>	<input type="checkbox"/>	<input type="checkbox"/>	<input type="checkbox"/>	<input type="checkbox"/>	<input type="checkbox"/>	<input type="checkbox"/>

<input checked="" type="checkbox"/>	<input type="checkbox"/>	<input type="checkbox"/>	<input checked="" type="checkbox"/>	<input type="checkbox"/>	<input type="checkbox"/>	<input type="checkbox"/>	<input type="checkbox"/>	<input type="checkbox"/>	<input type="checkbox"/>	<input type="checkbox"/>	<input type="checkbox"/>
<input checked="" type="checkbox"/>	<input type="checkbox"/>	<input type="checkbox"/>	<input type="checkbox"/>	<input type="checkbox"/>	<input type="checkbox"/>	<input type="checkbox"/>	<input type="checkbox"/>	<input type="checkbox"/>	<input type="checkbox"/>	<input type="checkbox"/>	<input type="checkbox"/>

■ Standard □ Option

MASTERSEAL 6

CONFIGURATION



5.0 Puller

5.1	TIZIP-Logo Metal mount	35 mm	
5.2	TIZIP-Logo Metal mount	25 mm	
5.3	TIZIP-Logo Metal mount	15 mm	
5.4	TIZIP-Logo Cord mount	35 mm	
5.5	TIZIP-Logo Cord mount	25 mm	
5.6	Cord mount Length	12 mm	
5.7	Cord mount Length	14 mm	
5.8	TIZIP-Logo Webbing mount	35 mm	
5.9	TIZIP-Logo Webbing mount	10 mm	

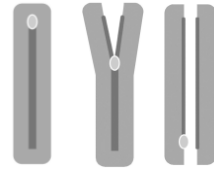

Black	RAL 7016	Pantone 000 C	Pantone 7501 C	Pantone 7497 C	Pantone 2426 C	Pantone 18-1555	Pantone 2174 C	Pantone 13-0752	Customized
<input checked="" type="checkbox"/>	<input type="checkbox"/>	<input type="checkbox"/>	<input type="checkbox"/>	<input type="checkbox"/>	<input type="checkbox"/>	<input type="checkbox"/>	<input type="checkbox"/>	<input type="checkbox"/>	<input type="checkbox"/>
<input checked="" type="checkbox"/>	<input type="checkbox"/>	<input type="checkbox"/>	<input type="checkbox"/>	<input type="checkbox"/>	<input type="checkbox"/>	<input type="checkbox"/>	<input type="checkbox"/>	<input type="checkbox"/>	<input type="checkbox"/>
<input checked="" type="checkbox"/>	<input type="checkbox"/>	<input type="checkbox"/>	<input type="checkbox"/>	<input type="checkbox"/>	<input type="checkbox"/>	<input type="checkbox"/>	<input type="checkbox"/>	<input type="checkbox"/>	<input type="checkbox"/>
<input checked="" type="checkbox"/>	<input type="checkbox"/>	<input type="checkbox"/>	<input type="checkbox"/>	<input type="checkbox"/>	<input type="checkbox"/>	<input type="checkbox"/>	<input type="checkbox"/>	<input type="checkbox"/>	<input type="checkbox"/>
<input checked="" type="checkbox"/>	<input type="checkbox"/>	<input type="checkbox"/>	<input type="checkbox"/>	<input type="checkbox"/>	<input type="checkbox"/>	<input type="checkbox"/>	<input type="checkbox"/>	<input type="checkbox"/>	<input type="checkbox"/>
<input checked="" type="checkbox"/>	<input type="checkbox"/>	<input type="checkbox"/>	<input type="checkbox"/>	<input type="checkbox"/>	<input type="checkbox"/>	<input type="checkbox"/>	<input type="checkbox"/>	<input type="checkbox"/>	<input type="checkbox"/>
<input checked="" type="checkbox"/>	<input type="checkbox"/>	<input type="checkbox"/>	<input type="checkbox"/>	<input type="checkbox"/>	<input type="checkbox"/>	<input type="checkbox"/>	<input type="checkbox"/>	<input type="checkbox"/>	<input type="checkbox"/>

Standard Option

MASTERSEAL 6

CONFIGURATION



6.0 Options

- 6.1 Q-strap Reinforcement (welded)
- 6.2 Q-strap Reinforcement (welded)
- 6.3 Pin-Box Left handling
- 6.4 Puller Customized Logo
- 6.5 Welding electrode

docking end
bottom stop

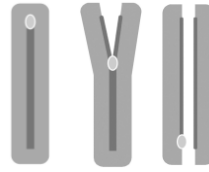
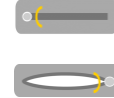

<input type="checkbox"/>	<input type="checkbox"/>	<input type="checkbox"/>
<input type="checkbox"/>	<input type="checkbox"/>	<input type="checkbox"/>
<input type="checkbox"/>	<input type="checkbox"/>	<input type="checkbox"/>
<input type="checkbox"/>	<input type="checkbox"/>	<input type="checkbox"/>
<input type="checkbox"/>	<input type="checkbox"/>	<input type="checkbox"/>

Black	RAL 7016	Pantone 000 C	Pantone 7501 C	Pantone 7497 C	Pantone 2426 C	Pantone 18-1555	Pantone 2174 C	Pantone 13-0752	Customized
<input checked="" type="checkbox"/>	<input type="checkbox"/>	<input type="checkbox"/>	<input type="checkbox"/>	<input type="checkbox"/>	<input type="checkbox"/>	<input type="checkbox"/>	<input type="checkbox"/>	<input type="checkbox"/>	<input type="checkbox"/>
<input checked="" type="checkbox"/>	<input type="checkbox"/>	<input type="checkbox"/>	<input type="checkbox"/>	<input type="checkbox"/>	<input type="checkbox"/>	<input type="checkbox"/>	<input type="checkbox"/>	<input type="checkbox"/>	<input type="checkbox"/>

■ Standard □ Option

MASTERSEAL 6

WWW.TIZIP.COM



Copyright © 2020

- Contents are subject to German copyright law.
- Duplication, processing, distribution require the written consent of TITEX.
- Copies are not permitted for commercial use.

Titex Vertriebs-GmbH

- Rainstrasse
- D- 91560 Heilsbronn
- info@tizip.com | www.tizip.com

Follow us on social media

