

MASTERSEAL 6

▪ VARIANTES	2
▪ DATOS TÉCNICOS	3
▪ APLICACIONES	4
▪ UTILIZACIÓN	5
▪ POSIBILIDADES DE CONFIGURACIÓN	6



PREMIUM WATERPROOF ZIPPERS MADE IN GERMANY



resistente al agua



herméticamente



presión verificado

MASTERSEAL 6

VARIANTES

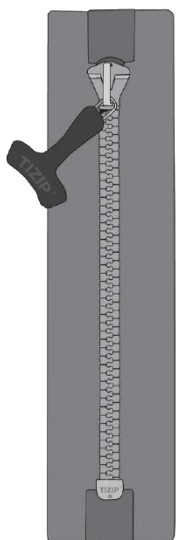

1 Deslizador

**cerrado
de ambos lados**

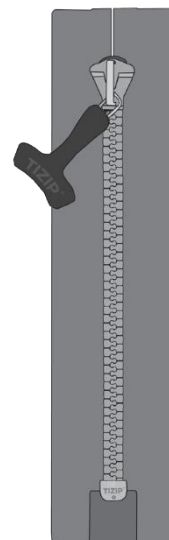

1 Deslizador

**divisible
en un lado**

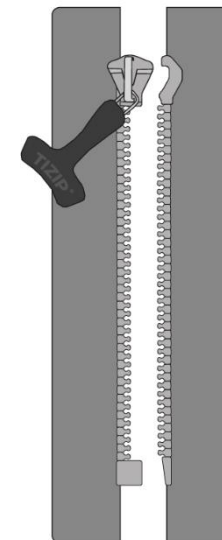

1 Deslizador

**divisible
de ambos lados**

MASTERSEAL 6

DATOS TÉCNICOS

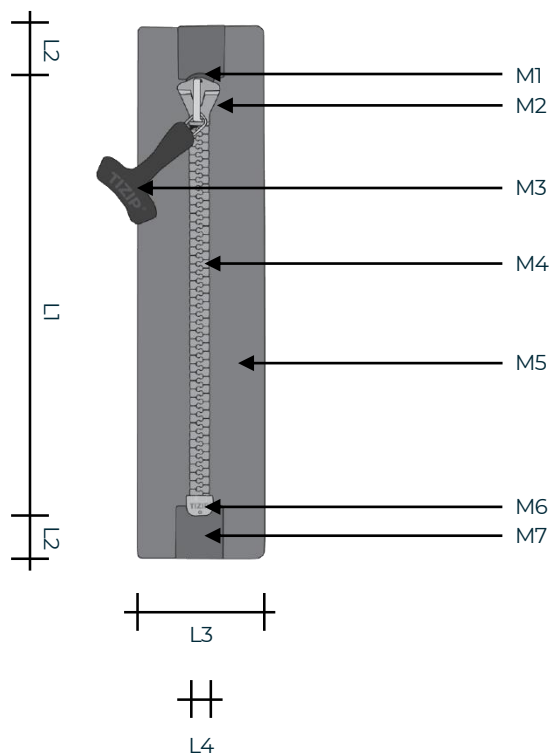

Geometría*

■ L1	Longitud a pedir:	130 - 7.000 mm
■ L2	Saliente:	16 mm / 25 mm
■ L3	Anchura:	40 mm / 50 mm
■ L4	Anchura de cadena:	6 mm

Materiales*

■ M1	Docking End:	Termoplástico Poliuretano
■ M2	Slider:	Polymer
■ M3	Puller:	Termoplástico Poliuretano
■ M4	Teeth:	Polyester
■ M5	Tape:	Poliuretano revestido Poliéster
■ M6	End Stop:	Termoplástico Poliuretano
■ M7	Pattern:	Poliuretano revestido Poliéster

Parámetros*

■ ☔	Estanqueidad:	200 mbar
■ ↔	Resistencia tracción transversal:	160 N/cm
■ 🌡️	Resistencia temperatura:	-30° a +70° C

Procesamiento*

Soldadura HF, coser/pegar con cinta o encolar

*Parámetros objetivo dependientes de la configuración

MASTERSEAL 6



APLICACIONES / RESISTENCIA DEL PRODUCTO / INCORPORACIÓN

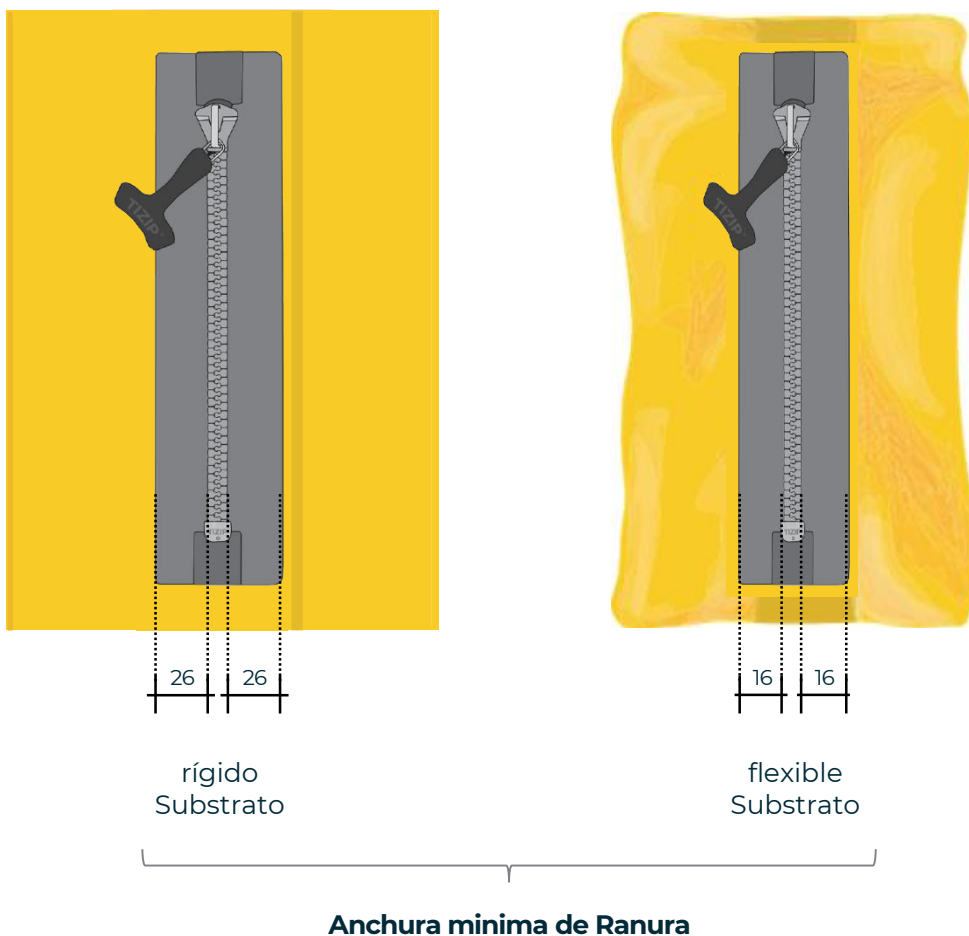

Aplicaciones

- Traje de baño
 - Chaquetas y pantalones por pesca con mosca
 - Chaquetas y pantalones de moto
 - Chaquetas y pantalones de hiking & esquia
 - Ropa protectora y de seguridad
 - Zapatos
 - Carpas y envolturas
 - Bolsas impermeables
 - Aplicaciones outdoor
- Deporte náutico
- Ropa
- actividad de exterior

Resistencia del Producto

- Resistente a la intemperie
- Adecuado para agua dulce y agua marina
- Resistencia a aceite y gasolina

Incorporación - Anchura mínima de Ranura

- En todos los trabajos de incorporación del cierre de cremallera recomendamos observar una anchura mínima de ranura de 26 mm.
- Por favor, respete una anchura mínima de ranura de 16 mm para garantizar un funcionamiento impecable.
- En la incorporación en tejidos rígidos o láminas (p. ej. espuma de neopreno), la anchura de la ranura, en el lado frontal y dorsal, debe ser de 26 mm.

MASTERSEAL 6

UTILIZACIÓN / LIMPIEZA / ALMACENAMIENTO

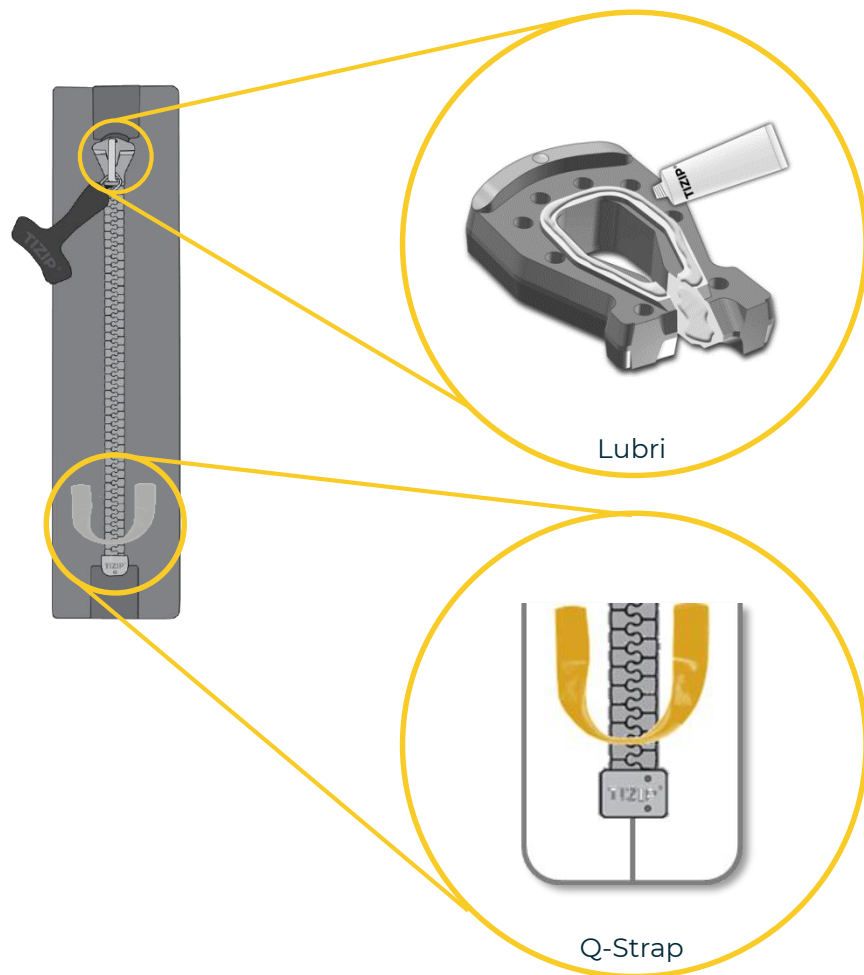

Utilización

- Accione cuidadosamente el deslizador. Si tira en forma oblicua de éste, podrá ser afectada la hermeticidad u otra característica importante.
- Evite estirar excesivamente los topes y las piezas terminales. No abra a fuerza los dos lados del cierre de cremallera.
- Preste atención a no doblar ni tampoco aplastar los cierres de cremallera.
- Cierre cada cierre de cremallera de modo que el deslizador se encuentre en la posición debida en el tope para garantizar la hermeticidad esperada.

Limpieza

- Recomendamos emplear una solución jabonosa y un cepillo fino.
- No utilice disolventes o detergentes agresivos dado que pueden perjudicar el funcionamiento previsto del cierre de cremallera.

Lubricación con Grase

- TIZIP® MasterSeal deben engrasarse de vez en cuando, por ejemplo después de un almacenamiento prolongado, en el tope.
- La lubricación debida antes del uso es decisiva para la capacidad de funcionamiento prevista. Limpie anticipadamente el tope del cierre de cremallera.
- Aplique la grase lubricante en el área del tope en el lado delantero a dorsal así como en el interior en el área de transición de la cadena del cierre de cremallera.
- No utilice grase lubricante a lo largo de la cadena del cierre de cremallera.
- Utilice grase lubricante original TIZIP®.
- Elimine toda grase lubricante excesiva ya que puede provocar manchas.

Almacenamiento

- Los cierres de cremallera TIZIP® deben almacenarse en forma completamente cerrada y sin doblarlos. El almacenamiento en estado abierto puede provocar curvas e inducir a fugas.

MASTERSEAL 6

POSIBILIDADES DE CONFIGURACIÓN



1.0 Tape

1.1	Overhang	25 mm
1.2	Overhang	16 mm
1.3	Width	40 mm
1.4	Width	50 mm
1.5	Optic	plain
1.6	Optic	structured
1.7	Optic	custom

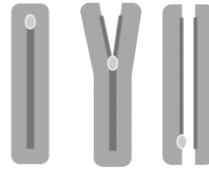

<input checked="" type="checkbox"/>	<input checked="" type="checkbox"/>	<input type="checkbox"/>
<input type="checkbox"/>	<input type="checkbox"/>	<input type="checkbox"/>
<input checked="" type="checkbox"/>	<input checked="" type="checkbox"/>	<input checked="" type="checkbox"/>
<input type="checkbox"/>	<input type="checkbox"/>	<input type="checkbox"/>
<input checked="" type="checkbox"/>	<input checked="" type="checkbox"/>	<input checked="" type="checkbox"/>
<input type="checkbox"/>	<input type="checkbox"/>	<input type="checkbox"/>
<input type="checkbox"/>	<input type="checkbox"/>	<input type="checkbox"/>



■ Standard □ Option

MASTERSEAL 6

POSIBILIDADES DE CONFIGURACIÓN



2.0 Pattern

- 2.1 Position front side
- 2.2 Position back side



3.0 Teeth

- 3.1 Regular Quality 200 N/cm
- 3.2 Performance optimized (from 01.04.20) Easy operation & durability 160 N/cm

4.0 Slider

- 4.1 Standard Quality Polymer 0,2 bar
- 4.2 Brake System Polymer 0,0 bar



Option	Black	RAL 7016	Pantone 000 C	Pantone 7501 C	Pantone 7497 C	Pantone 2426 C	Pantone 18-1555	Pantone 2174 C	Pantone 13-0752	Customized
2.1 Position front side	■	□	□	□	□	□	□	□	□	□
2.2 Position back side	■	□	□	□	□	□	□	□	□	□
3.1 Regular Quality 200 N/cm	■	□	□	□	□	□	□	□	□	□
3.2 Performance optimized 160 N/cm	■	□	□	□	□	□	□	□	□	□
4.1 Standard Quality Polymer 0,2 bar	■	□	□	□	□	□	□	□	□	□
4.2 Brake System Polymer 0,0 bar	■	□	□	□	□	□	□	□	□	□























■ Standard □ Option

MASTERSEAL 6



POSIBILIDADES DE CONFIGURACIÓN

5.0 Puller

															
5.1	TIZIP-Logo Metal mount	35 mm		<input type="checkbox"/>	<input type="checkbox"/>	<input checked="" type="checkbox"/>	<input type="checkbox"/>	<input type="checkbox"/>	<input type="checkbox"/>	<input type="checkbox"/>	<input type="checkbox"/>	<input type="checkbox"/>	<input type="checkbox"/>	<input type="checkbox"/>	<input type="checkbox"/>
5.2	TIZIP-Logo Metal mount	25 mm		<input type="checkbox"/>	<input type="checkbox"/>	<input checked="" type="checkbox"/>	<input type="checkbox"/>	<input type="checkbox"/>	<input type="checkbox"/>	<input type="checkbox"/>	<input type="checkbox"/>	<input type="checkbox"/>	<input type="checkbox"/>	<input type="checkbox"/>	<input type="checkbox"/>
5.3	TIZIP-Logo Metal mount	15 mm		<input checked="" type="checkbox"/>	<input checked="" type="checkbox"/>	<input checked="" type="checkbox"/>	<input type="checkbox"/>	<input type="checkbox"/>	<input type="checkbox"/>	<input type="checkbox"/>	<input type="checkbox"/>	<input type="checkbox"/>	<input type="checkbox"/>	<input type="checkbox"/>	<input type="checkbox"/>
5.4	TIZIP-Logo Cord mount	35 mm		<input type="checkbox"/>	<input type="checkbox"/>	<input checked="" type="checkbox"/>	<input type="checkbox"/>	<input type="checkbox"/>	<input type="checkbox"/>	<input type="checkbox"/>	<input type="checkbox"/>	<input type="checkbox"/>	<input type="checkbox"/>	<input type="checkbox"/>	<input type="checkbox"/>
5.5	TIZIP-Logo Cord mount	25 mm		<input type="checkbox"/>	<input type="checkbox"/>	<input checked="" type="checkbox"/>	<input type="checkbox"/>	<input type="checkbox"/>	<input type="checkbox"/>	<input type="checkbox"/>	<input type="checkbox"/>	<input type="checkbox"/>	<input type="checkbox"/>	<input type="checkbox"/>	<input type="checkbox"/>
5.6	Cord mount Length	12 mm		<input type="checkbox"/>	<input type="checkbox"/>	<input checked="" type="checkbox"/>	<input type="checkbox"/>	<input type="checkbox"/>	<input type="checkbox"/>	<input type="checkbox"/>	<input type="checkbox"/>	<input type="checkbox"/>	<input type="checkbox"/>	<input type="checkbox"/>	<input type="checkbox"/>
5.7	Cord mount Length	14 mm		<input type="checkbox"/>	<input type="checkbox"/>	<input checked="" type="checkbox"/>	<input type="checkbox"/>	<input type="checkbox"/>	<input type="checkbox"/>	<input type="checkbox"/>	<input type="checkbox"/>	<input type="checkbox"/>	<input type="checkbox"/>	<input type="checkbox"/>	<input type="checkbox"/>
5.8	TIZIP-Logo Webbing mount	35 mm		<input type="checkbox"/>	<input type="checkbox"/>	<input checked="" type="checkbox"/>	<input type="checkbox"/>	<input type="checkbox"/>	<input type="checkbox"/>	<input type="checkbox"/>	<input type="checkbox"/>	<input type="checkbox"/>	<input type="checkbox"/>	<input type="checkbox"/>	<input type="checkbox"/>
5.9	TIZIP-Logo Webbing mount	10 mm		<input type="checkbox"/>	<input type="checkbox"/>	<input checked="" type="checkbox"/>	<input type="checkbox"/>	<input type="checkbox"/>	<input type="checkbox"/>	<input type="checkbox"/>	<input type="checkbox"/>	<input type="checkbox"/>	<input type="checkbox"/>	<input type="checkbox"/>	<input type="checkbox"/>

■ Standard □ Option

MASTERSEAL 6

POSIBILIDADES DE CONFIGURACIÓN



6.0 Options

Option	Diagram	Option 1	Option 2	Option 3
6.1 Q-strap Reinforcement (welded) docking end		<input type="checkbox"/>	<input type="checkbox"/>	<input type="checkbox"/>
6.2 Q-strap Reinforcement (welded) bottom stop		<input type="checkbox"/>	<input type="checkbox"/>	<input type="checkbox"/>
6.3 Pin-Box Left handling		<input type="checkbox"/>	<input type="checkbox"/>	<input type="checkbox"/>
6.4 Puller Customized Logo		<input type="checkbox"/>	<input type="checkbox"/>	<input type="checkbox"/>
6.5 Welding electrode		<input type="checkbox"/>	<input type="checkbox"/>	<input type="checkbox"/>

Black	RAL 7016	Pantone 000 C	Pantone 7501 C	Pantone 7497 C	Pantone 2426 C	Pantone 18-1555	Pantone 2174 C	Pantone 13-0752	Customized
<input checked="" type="checkbox"/>	<input type="checkbox"/>	<input type="checkbox"/>	<input type="checkbox"/>	<input type="checkbox"/>	<input type="checkbox"/>	<input type="checkbox"/>	<input type="checkbox"/>	<input type="checkbox"/>	<input type="checkbox"/>
<input checked="" type="checkbox"/>	<input type="checkbox"/>	<input type="checkbox"/>	<input type="checkbox"/>	<input type="checkbox"/>	<input type="checkbox"/>	<input type="checkbox"/>	<input type="checkbox"/>	<input type="checkbox"/>	<input type="checkbox"/>

■ Standard □ Option

MASTERSEAL 6

WWW.TIZIP.COM



Derechos de autor © 2020

- Los contenidos están sujetos a la ley de derechos de autor alemana.
- La duplicación, el procesamiento y la distribución requieren el consentimiento por escrito de TITEX. No se permiten copias para uso comercial.

Titex Vertriebs-GmbH

- Rainstrasse
- D- 91560 Heilsbronn
- info@tizip.com | www.tizip.com

Follow us on social media



MADE IN GERMANY