

# WATERSEAL

▪ VERSIONS	2
▪ TECHNICAL DATASHEET	3
▪ APPLICATIONS	4
▪ MAINTENANCE	5
▪ CONFIGURATION	7



PREMIUM WATERPROOF ZIPPERS MADE IN GERMANY



splash proof

WATERSEAL

VERSIONS

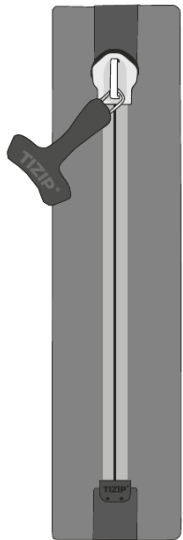

1 slider



**both sides closed**

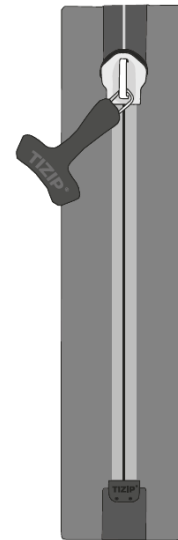

1 slider



**one side open**

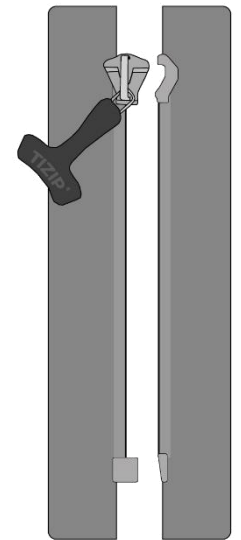

1 slider



**separable**

# WATERSEAL

## TECHNICAL DATASHEET

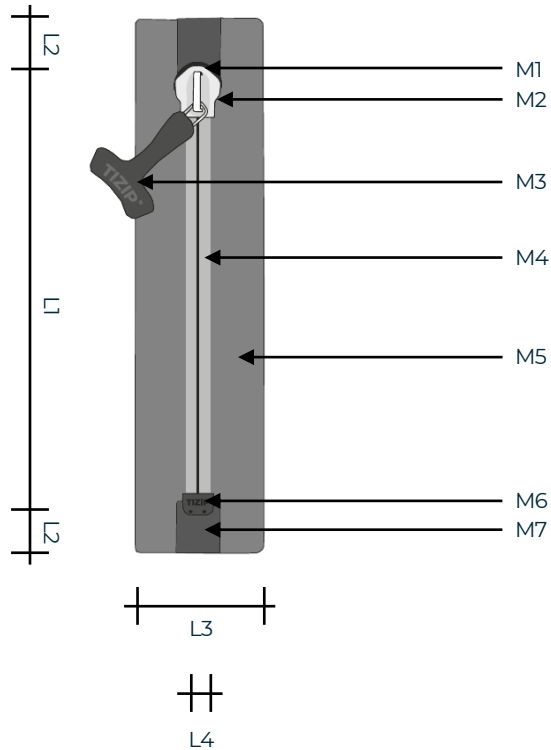

### Geometry\*

- L1 Order length: 130 - >>10.000 mm
- L2 Overhang length: 16 mm / 25 mm
- L3 Tape width: 50 mm / 70 mm
- L4 Chain width: 11 mm

### Material\*

- M1 Docking End: Thermoplastic Polyurethane
- M2 Slider: Metal, Polymer
- M3 Puller: Polyurethane
- M4 Chain: Polyester Monofilament
- M5 Tape: Polyurethan coated Polyester
- M6 End Stop: Thermoplastic Polyurethan
- M7 Pattern: Polyurethan coated Polyester

### Parameter\*

- ☔ Sealing strength: 50 mbar (splash proof)
- ↔ Cross tension: 300 N/cm
- 🌡️ Temperatur: -30° to +70° C

### Installation\*

HF welding, sewing/taping, gluing

\*configuration-dependent target values

# WATERSEAL

## APPLICATIONS / DURABILITY / INSTALLATION

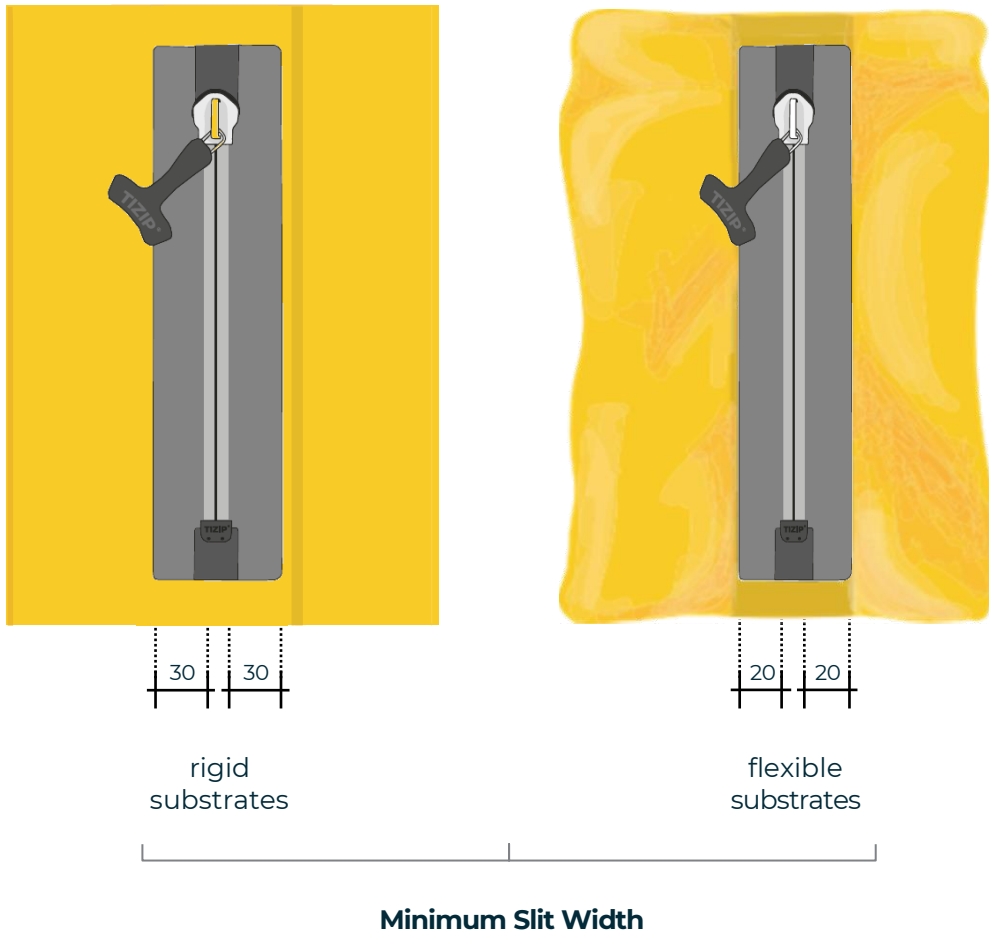

### Applications

- Protective & survival
  - Shoes
  - Tents, covers
  - Backpacks, duffel bags, cooler bags
  - Other
- } Clothing
- } Outdoor

### Durability

- Weather-resistant
- Suitable for both freshwater and saltwater applications
- Oil and gasoline-resistant

### Installation

- A minimum slit width of 20 mm is recommended for all types of substrates.
- With rigid substrates (fabric, foils, neoprene, etc.) the slit width should be increased to at least 30 mm.
- The zip must not be roughened for installation.
- The welding temperature, welding time, welding electrode and contact pressure must be optimally adjusted to the zipper (material, geometry, etc.). Tests are recommended before installation.

# WATERSEAL

## BEST PRACTICE / CLEANING / STORAGE

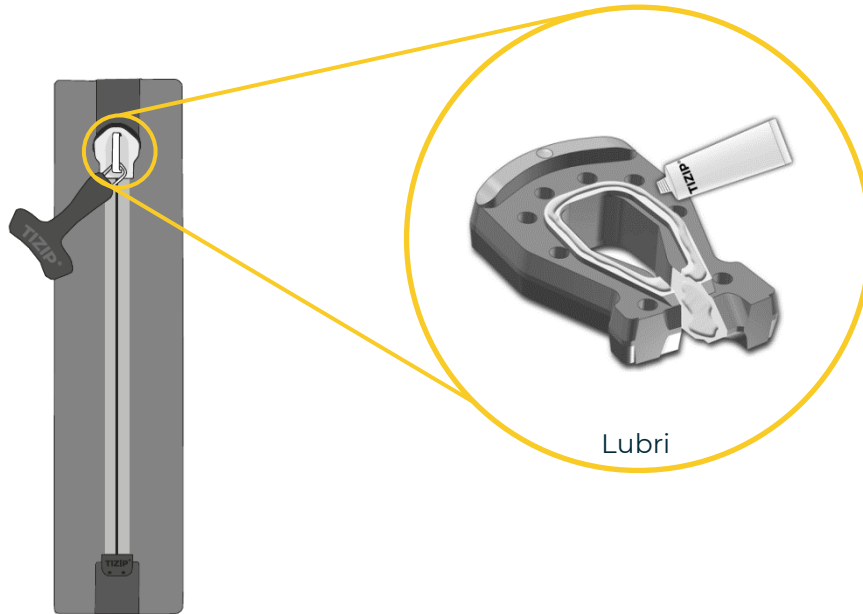

### Best Practice

- Operate the slide gently. Pulling at an angle can negatively affect the zippers, e.g. their tightness.
- Avoid overstretching the docking end and end pieces if necessary by using the optional Q-Strap. Do not pull the two sides of the zipper apart forcefully.
- Be careful not to fold or squeeze the zippers.
- Close each zipper carefully so that the slider lies correctly in the docking end to guarantee tightness.

### Cleaning

- Dirt particles, especially between the teeth, can affect the sealing lip and thus negatively affect the tightness and durability.
- We recommend a light soapy water and a fine brush.
- Do not use solvents or aggressive cleaning agents as these negatively affect the function of the zipper.

### Lubrification

- MasterSeal zippers need to be lubricated from time to time.
- Apply gently the lubricating grease in the area of the docking end on the front and back, as well as on the inside at the transition to the zip chain.
- Do not use grease along the zipper chain.
- Remove remaining lubricating grease to avoid stains.
- Use the original TIZIP® lubricating grease.

### Storage

- TIZIP® zippers should be stored completely closed, dry, clean and without bending.

# WATERSEAL

## REPAIR MANUAL OVER-STRESSING

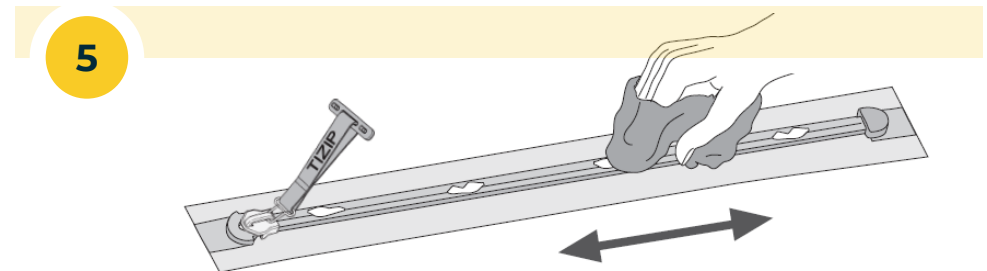
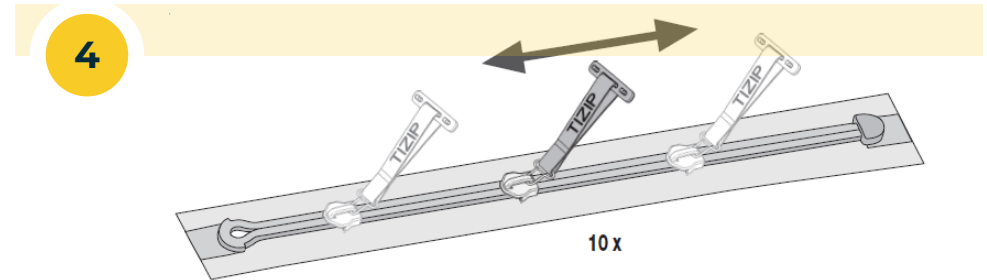
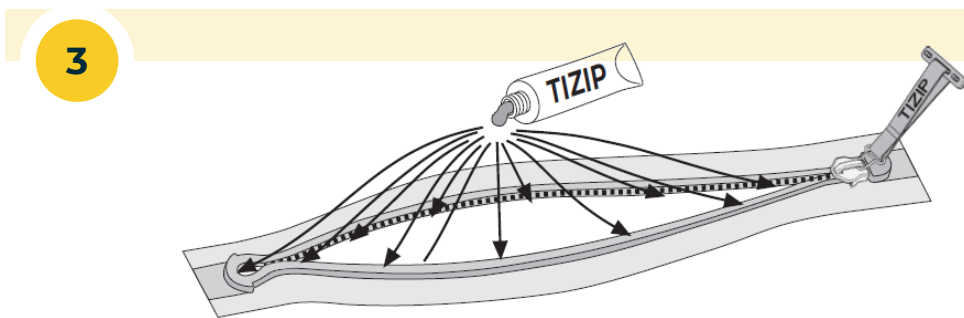
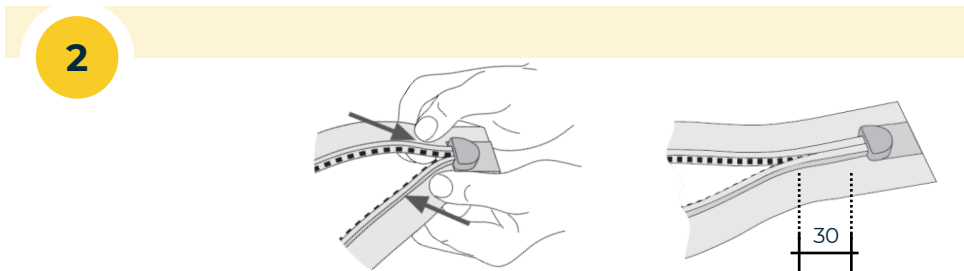
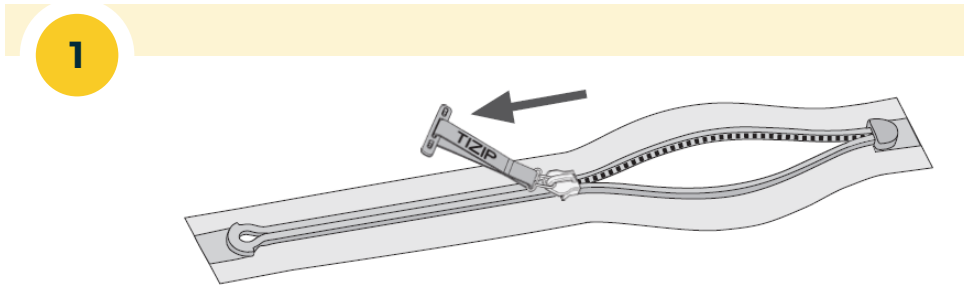

### OVER-STRESSING

- If there is an overload during closing, it can happen that the chain remains open, but is not damaged.
- To repair, simply pull the slider back and close the zipper again with less lateral tension.
- If the chain is open up to the lower slider stop, the lower 3 cm must first be engaged by hand.
- Then slide the slider back into the restored area.

# WATERSEAL CONFIGURATION



## 1.0 Tape

1.1	Overhang	25 mm
1.2	Overhang	16 mm
1.3	Width	50 mm
1.4	Width	70 mm
1.5	Optic	plain

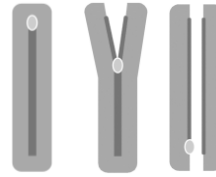

## 2.0 Pattern

2.1	Position	front side
2.2	Optic	plain



1.1	<input checked="" type="checkbox"/>	<input checked="" type="checkbox"/>	<input checked="" type="checkbox"/>	<input checked="" type="checkbox"/>	<input checked="" type="checkbox"/>	<input checked="" type="checkbox"/>	<input checked="" type="checkbox"/>	<input checked="" type="checkbox"/>	<input checked="" type="checkbox"/>	<input checked="" type="checkbox"/>
1.2	<input type="checkbox"/>	<input type="checkbox"/>	<input type="checkbox"/>	<input type="checkbox"/>	<input type="checkbox"/>	<input type="checkbox"/>	<input type="checkbox"/>	<input type="checkbox"/>	<input type="checkbox"/>	<input type="checkbox"/>
1.3	<input type="checkbox"/>	<input type="checkbox"/>	<input type="checkbox"/>	<input type="checkbox"/>	<input type="checkbox"/>	<input type="checkbox"/>	<input type="checkbox"/>	<input type="checkbox"/>	<input type="checkbox"/>	<input type="checkbox"/>
1.4	<input checked="" type="checkbox"/>	<input checked="" type="checkbox"/>	<input checked="" type="checkbox"/>	<input checked="" type="checkbox"/>	<input checked="" type="checkbox"/>	<input checked="" type="checkbox"/>	<input checked="" type="checkbox"/>	<input checked="" type="checkbox"/>	<input checked="" type="checkbox"/>	<input checked="" type="checkbox"/>
1.5	<input checked="" type="checkbox"/>	<input type="checkbox"/>	<input type="checkbox"/>	<input type="checkbox"/>	<input type="checkbox"/>	<input type="checkbox"/>	<input type="checkbox"/>	<input type="checkbox"/>	<input type="checkbox"/>	<input type="checkbox"/>
2.1	<input checked="" type="checkbox"/>	<input type="checkbox"/>	<input type="checkbox"/>	<input type="checkbox"/>	<input type="checkbox"/>	<input type="checkbox"/>	<input type="checkbox"/>	<input type="checkbox"/>	<input type="checkbox"/>	<input type="checkbox"/>
2.2	<input checked="" type="checkbox"/>	<input type="checkbox"/>	<input type="checkbox"/>	<input type="checkbox"/>	<input type="checkbox"/>	<input type="checkbox"/>	<input type="checkbox"/>	<input type="checkbox"/>	<input type="checkbox"/>	<input type="checkbox"/>

Standard  Option

# WATERSEAL CONFIGURATION



## 3.0 Teeth

3.1 Regular Quality 300 N/cm

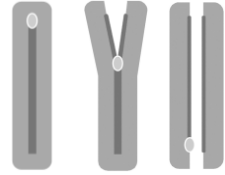

■ ■ ■

## 4.0 Slider

4.1 Regular Quality Metal 0,7 bar



■ ■

4.2 Regular Quality Polymer 0,0 bar



■



■ □ □ □ □ □ □ □ □ □ □

■ Standard □ Option



# WATERSEAL CONFIGURATION



## 5.0 Puller

- 5.1 TIZIP-Logo Metal mount 35 mm
- 5.2 TIZIP-Logo Metal mount 25 mm
- 5.3 TIZIP-Logo Cord mount 35 mm
- 5.4 TIZIP-Logo Cord mount 25 mm
- 5.5 Cord mount Length 12 mm
- 5.6 Cord mount Length 14 mm
- 5.7 TIZIP-Logo Webbing mount 35 mm
- 5.8 TIZIP-Logo Webbing mount 10 mm
- 5.9 TIZIP-Logo Belt mount 70 mm

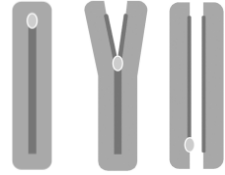

Black	RAL 7016	Pantone 000 C	Pantone 7501 C	Pantone 7497 C	Pantone 2426 C	Pantone 18-1555	Pantone 2174 C	Pantone 13-0752	Customized
■	□	□	□	□	□	□	□	□	□
■	□	□	□	□	□	□	□	□	□
■	□	□	□	□	□	□	□	□	□
■	□	□	□	□	□	□	□	□	□
■	□	□	□	□	□	□	□	□	□
■	□	□	□	□	□	□	□	□	□
■	□	□	□	□	□	□	□	□	□
■	□	□	□	□	□	□	□	□	□
■	□	□	□	□	□	□	□	□	□

■ Standard □ Option

WATERSEAL

[WWW.TIZIP.COM](http://WWW.TIZIP.COM)



**Copyright © 2020**

- Contents are subject to German copyright law.
- Duplication, processing, distribution require the written consent of TITEX.
- Copies are not permitted for commercial use.

**Titex Vertriebs-GmbH**

- Rainstrasse
- D- 91560 Heilsbronn
- [info@tizip.com](mailto:info@tizip.com) | [www.tizip.com](http://www.tizip.com)

Follow us on social media

