

MASTERSEAL 6

▪ VERSIONS	2
▪ TECHNICAL DATASHEET	3
▪ APPLICATIONS	4
▪ MAINTENANCE	5
▪ CONFIGURATION	6



PREMIUM WATERPROOF ZIPPERS MADE IN GERMANY



waterproof



airtight



pressure tested

MASTERSEAL 6

VERSIONS

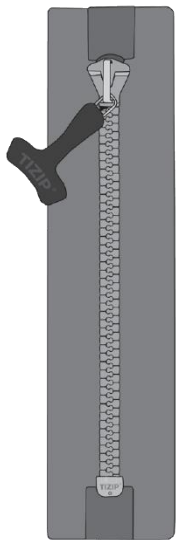

MasterSeal
HE

1 slider

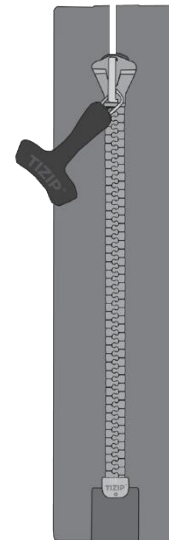

both sides closed



MasterSeal
TS

1 slider

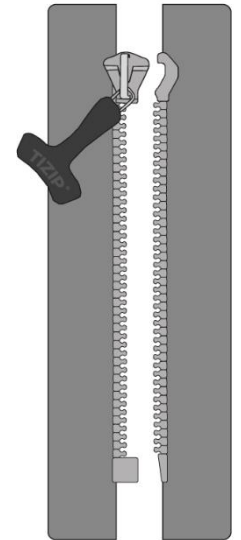
one side open



MasterSeal
PB

1 slider

separable

MASTERSEAL 6

TECHNICAL DATASHEET

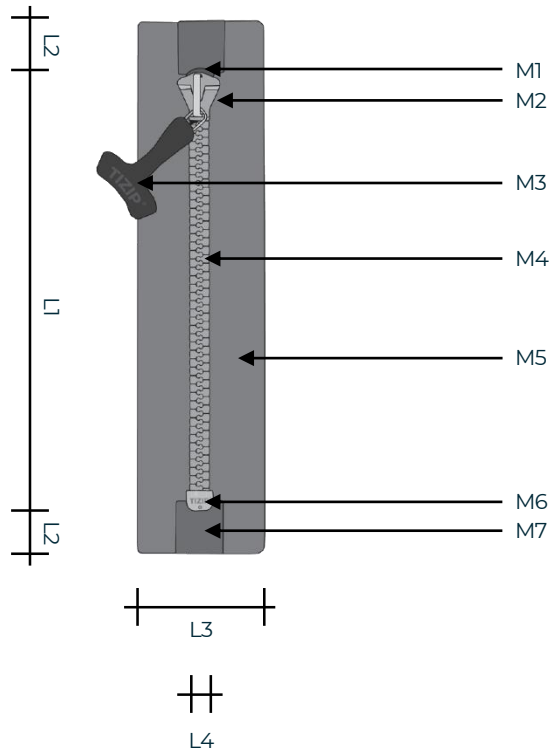

Geometry*

- L1 Order length: 130 - 10.000 mm
- L2 Overhang length: 16 mm / 25 mm
- L3 Tape width: 40 mm / 50 mm
- L4 Chain width: 6 mm

Material*

- M1 Docking End: Thermoplastic Polyurethane
- M2 Slider: Polymer
- M3 Puller: Thermoplastic Polyurethane
- M4 Teeth: Thermoplastic Polyurethane
- M5 Tape: Polyurethan coated Polyester
- M6 End Stop V8: Thermoplastic Polyurethan
- M7 Pattern: Polyurethan coated Polyester

Parameter*

- ☔ Sealing strength: 200 mbar (IPX7)
- ↔ Cross tension: 160 N/cm
- 🌡️ Temperatur: -30° to +70° C

Installation*

HF welding, sewing + taping, or gluing

*configuration-dependent target values

MASTERSEAL 6



APPLICATIONS / DURABILITY / INSTALLATION

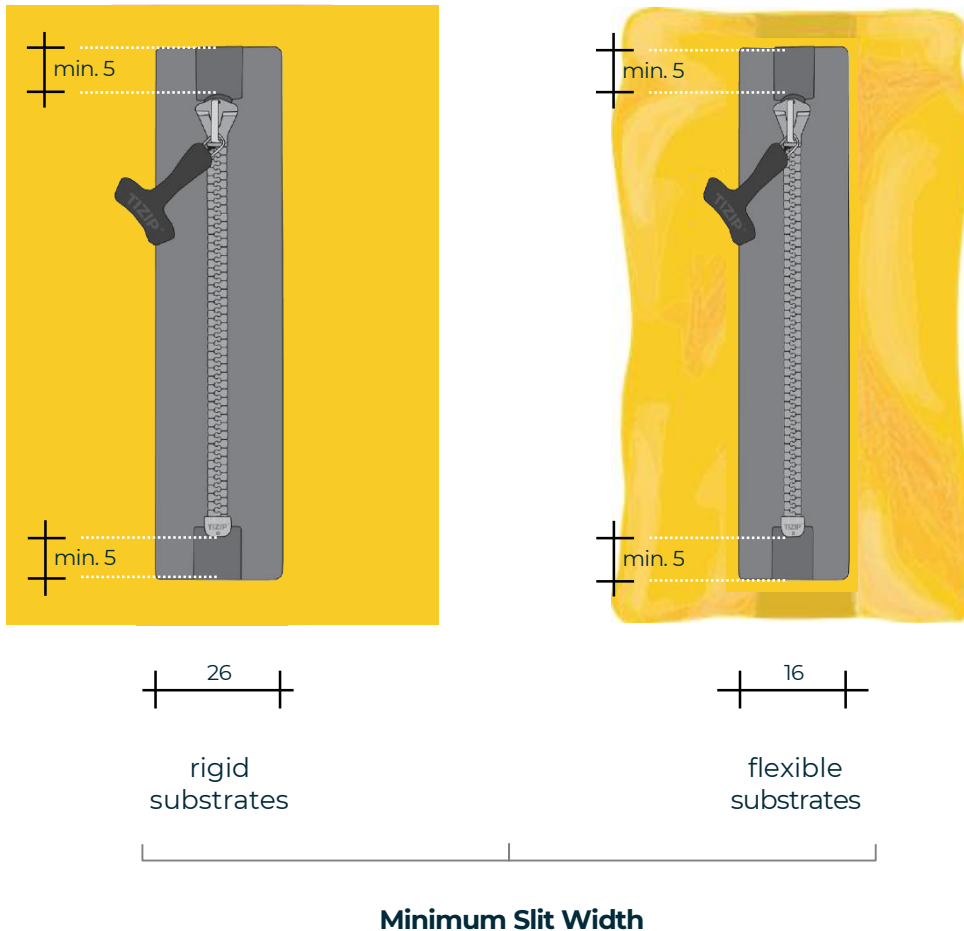

Applications

- Swimming shorts
 - Waders
 - Motorcycle jackets & pants
 - Hiking- / skiing jackets & pants
 - Protective & survival
 - Shoes
 - Tents, covers
 - Backpacks, duffle bags, cooler bags
 - Other
- Water Sports
- Clothing
- Outdoor

Durability

- Weather-resistant
- Suitable for both freshwater and saltwater applications
- Oil and gasoline-resistant

Installation

- A minimum slit width of 16 mm is recommended for all types of substrates.
- With rigid substrates (fabric, foils, neoprene, etc.) the slit width should be increased to at least 26 mm.
- The zip must not be roughened for installation.
- The welding temperature, welding time, welding electrode and contact pressure must be optimally adjusted to the zipper (material, geometry, etc.). Tests are recommended before installation.

MASTERSEAL 6



BEST PRACTICE / CLEANING / STORAGE

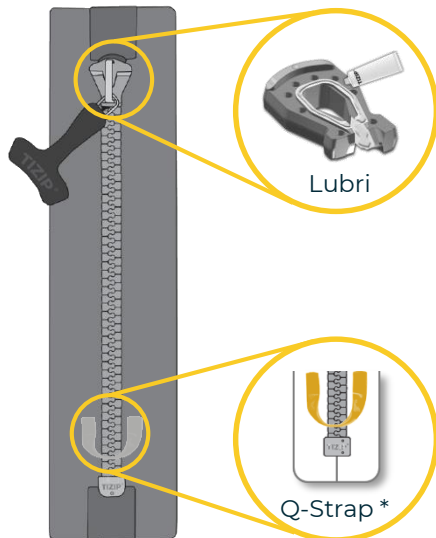

* Do not use Q-strap as hanging hook.

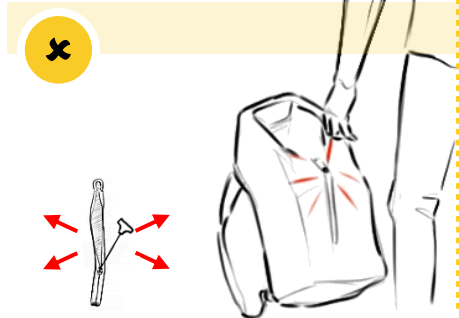
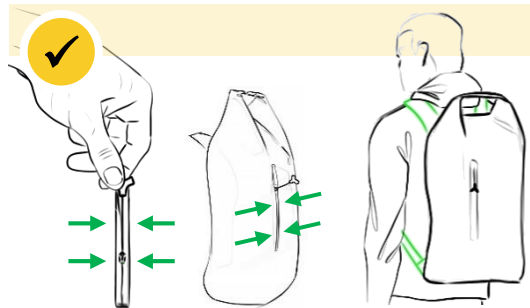

Best Practice

- Operate the slide gently. Pulling at an angle can negatively affect the zippers, e.g. their tightness.
- Avoid overstretching the docking end and end pieces if necessary by using the optional Q-Strap. Do not pull the two sides of the zipper apart forcefully.
- Be careful not to fold or squeeze the zippers.
- Close each zipper carefully so that the slider lies correctly in the docking end to guarantee tightness.

Cleaning

- Dirt particles, especially between the teeth, can affect the sealing lip and thus negatively affect the tightness and durability.
- We recommend a light soapy water and a fine brush.
- Do not use solvents or aggressive cleaning agents as these negatively affect the function of the zipper.

Lubrification

- MasterSeal zippers need to be lubricated from time to time.
- Apply gently the lubricating grease in the area of the docking end on the front and back, as well as on the inside at the transition to the zip chain.
- Do not use grease along the zipper chain.
- Remove remaining lubricating grease to avoid stains.
- Use the original TIZIP® lubricating grease.

Storage

- TIZIP® zippers should be stored completely closed, dry, clean and without bending.

MASTERSEAL 6

CONFIGURATION

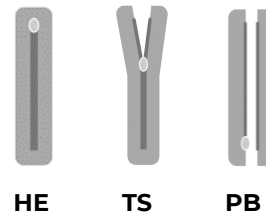

1.0 GEOMETRY (1)

1.1	L1 - Length	230 – 10.000 mm	<----- (more than 10.000 mm on request) ----->		
1.2	L2 - Overhang	25 / 25 mm	■		
1.3	L2 - Overhang	16 / 16 mm	□		
1.4	L2 - Overhang	10 / 25 mm		■	
1.5	L2 - Overhang	10 / 16 mm		□	
1.6	L2 - Overhang	10 / 10 mm			□
1.7	L2 - Overhang Customized	0-50 / 0-50 mm	□	□	□

■ Standard □ Option

MASTERSEAL 6

CONFIGURATION

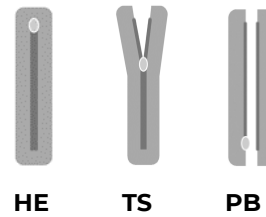

1.0 GEOMETRY (2)

1.8	L3 - Width	40 mm	■	■	■
1.9	L3 - Width	50 mm	□	□	□

■ Standard □ Option

MASTERSEAL 6

CONFIGURATION

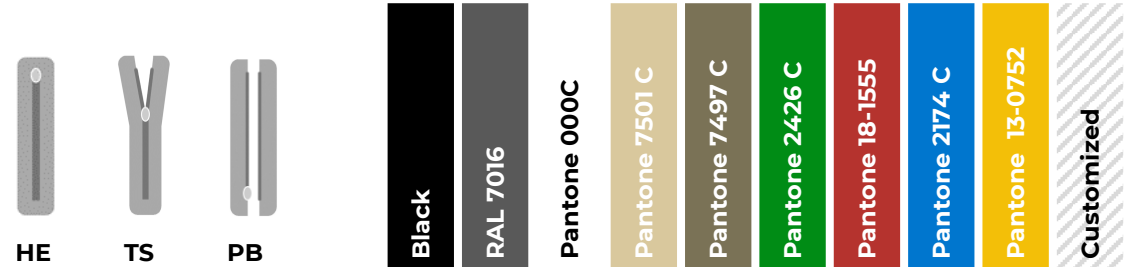

2.0 OPTIC

			HE	TS	PB	Black	RAL 7016	Pantone 000C	Pantone 7501 C	Pantone 7497 C	Pantone 2426 C	Pantone 18-1555	Pantone 2174 C	Pantone 13-0752	Customized
2.1	M5 - Tape	plain	■	■	■	■	□	□	□	□	□	□	□	□	□
2.2	M5 - Tape	structured	□	□	□	■	□	□	□	□	□	□	□	□	□
2.3	M5 - Tape	customized	□	□	□	■	□	□	□	□	□	□	□	□	□
2.4	M7 - Pattern	front side	■	■		■	□	□	□	□	□	□	□	□	□
2.5	M7 - Pattern	back side	□	□		■	□	□	□	□	□	□	□	□	□

■ Standard □ Option

MASTERSEAL 6

CONFIGURATION

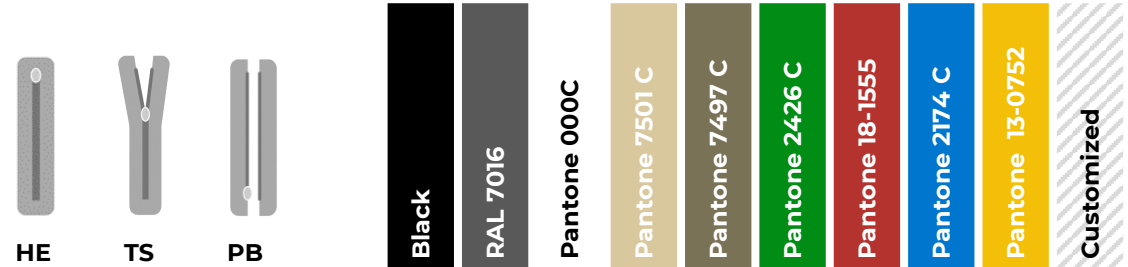

3.0 SLIDER

			HE	TS	PB	Black	RAL 7016	Pantone 000C	Pantone 7501 C	Pantone 7497 C	Pantone 2426 C	Pantone 18-1555	Pantone 2174 C	Pantone 13-0752	Customized
3.1	M2 - Polymer Slider		■	□	■	■	□	□	□	□	□	□	□	□	□
3.2	M2 - Polymer Slider	Lock-System	□	■	□	■	□	□	□	□	□	□	□	□	□

■ Standard □ Option

MASTERSEAL 6

CONFIGURATION

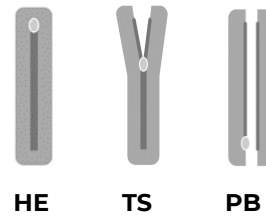

4.0 PULLER

			HE	TS	PB	Black	RAL 7016	Pantone 000C	Pantone 7501 C	Pantone 7497 C	Pantone 2426 C	Pantone 18-1555	Pantone 2174 C	Pantone 13-0752	Customized	
4.1	M3 - Puller 35M	35 mm		<input type="checkbox"/>	<input type="checkbox"/>	<input type="checkbox"/>	<input checked="" type="checkbox"/>	<input type="checkbox"/>	<input type="checkbox"/>	<input type="checkbox"/>	<input type="checkbox"/>	<input type="checkbox"/>	<input type="checkbox"/>	<input type="checkbox"/>	<input type="checkbox"/>	<input type="checkbox"/>
4.2	M3 - Puller 25M	25 mm		<input type="checkbox"/>	<input type="checkbox"/>	<input type="checkbox"/>	<input checked="" type="checkbox"/>	<input type="checkbox"/>	<input type="checkbox"/>	<input type="checkbox"/>	<input type="checkbox"/>	<input type="checkbox"/>	<input type="checkbox"/>	<input type="checkbox"/>	<input type="checkbox"/>	<input type="checkbox"/>
4.3	M3 - Puller 15M	15 mm		<input checked="" type="checkbox"/>	<input checked="" type="checkbox"/>	<input checked="" type="checkbox"/>	<input checked="" type="checkbox"/>	<input type="checkbox"/>	<input type="checkbox"/>	<input type="checkbox"/>	<input type="checkbox"/>	<input type="checkbox"/>	<input type="checkbox"/>	<input type="checkbox"/>	<input type="checkbox"/>	<input type="checkbox"/>
4.4	M3 - Puller 35C	35 mm		<input type="checkbox"/>	<input type="checkbox"/>	<input type="checkbox"/>	<input checked="" type="checkbox"/>	<input type="checkbox"/>	<input type="checkbox"/>	<input type="checkbox"/>	<input type="checkbox"/>	<input type="checkbox"/>	<input type="checkbox"/>	<input type="checkbox"/>	<input type="checkbox"/>	<input type="checkbox"/>
4.5	M3 - Puller 25C	25 mm		<input type="checkbox"/>	<input type="checkbox"/>	<input type="checkbox"/>	<input checked="" type="checkbox"/>	<input type="checkbox"/>	<input type="checkbox"/>	<input type="checkbox"/>	<input type="checkbox"/>	<input type="checkbox"/>	<input type="checkbox"/>	<input type="checkbox"/>	<input type="checkbox"/>	<input type="checkbox"/>
4.6	M3 - Puller 35W	35 mm		<input type="checkbox"/>	<input type="checkbox"/>	<input type="checkbox"/>	<input checked="" type="checkbox"/>	<input type="checkbox"/>	<input type="checkbox"/>	<input type="checkbox"/>	<input type="checkbox"/>	<input type="checkbox"/>	<input type="checkbox"/>	<input type="checkbox"/>	<input type="checkbox"/>	<input type="checkbox"/>
4.7	M3 - Puller 10W	10 mm		<input type="checkbox"/>	<input type="checkbox"/>	<input type="checkbox"/>	<input checked="" type="checkbox"/>	<input type="checkbox"/>	<input type="checkbox"/>	<input type="checkbox"/>	<input type="checkbox"/>	<input type="checkbox"/>	<input type="checkbox"/>	<input type="checkbox"/>	<input type="checkbox"/>	<input type="checkbox"/>

■ Standard □ Option

MASTERSEAL 6

CONFIGURATION

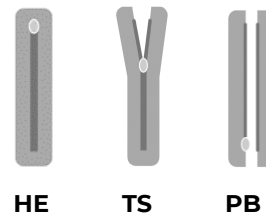

5.0 OPTIONS

5.1	Q-Strap	at docking end		<input type="checkbox"/>	<input checked="" type="checkbox"/>
5.2	Q-Strap	at end stop		<input type="checkbox"/>	<input checked="" type="checkbox"/>
5.3	Left handling	Pin/Box		<input type="checkbox"/>	
5.4	Puller Customized Logo	only with 4.1		<input type="checkbox"/>	<input type="checkbox"/>

■ Standard □ Option

MASTERSEAL 6

WWW.TIZIP.COM



Copyright © 2022

- Contents are subject to German copyright law.
- Duplication, processing, distribution require the written consent of GDS.
- Copies are not permitted for commercial use.

GDS GmbH & Co. KG

- Rainstrasse 8
- 91560 Heilsbronn
- Germany
- info@tizip.com | www.tizip.com

Follow us on social media

